

 **JAMES BAROUD**

EN USER GUIDE

FR Guide de L'utilisateur

DE Benutzerhandbuch

ES Guía del usuario

PT Guia de utilizador

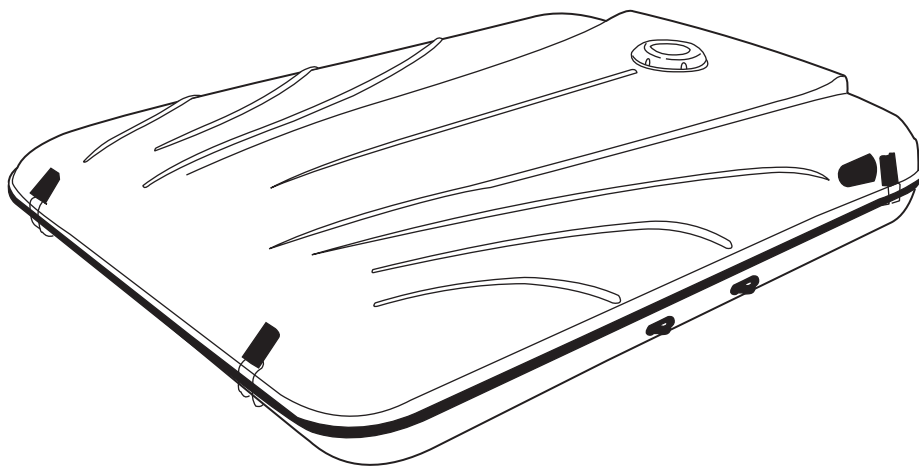

Space

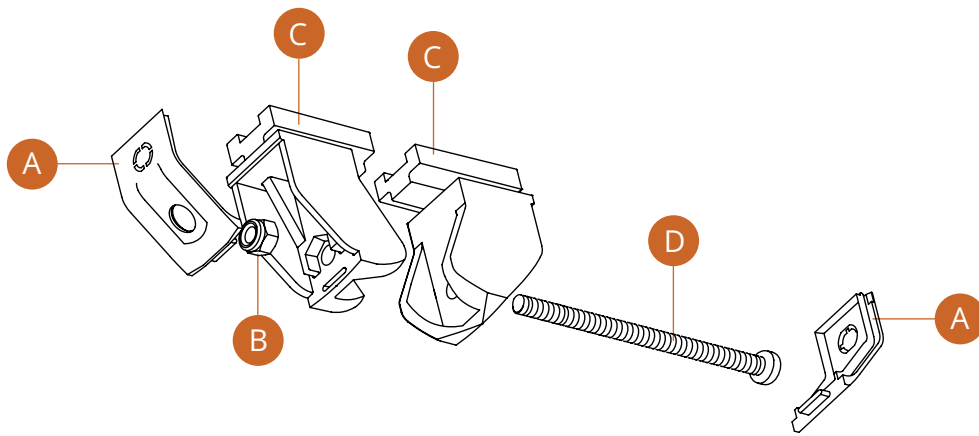

EN **Mattress placement instructions**

FR Instructions de placement de matelas

DE Matratze Platzierungsanweisungen

ES Instrucciones de colocación del colchón

PT Instruções de posicionamento do colchão

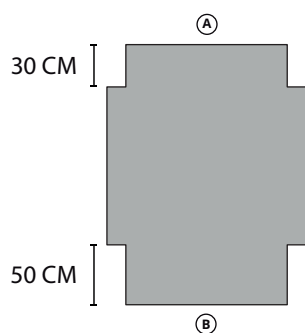

(A) **EN Tent rear**
 FR Arrière de la tente
 DE Zelt hinten
 ES Trasera de la tienda
 PT Traseira da tenda

(B) **EN Tent front**
 FR Avant de la tente
 DE Zelt vorne
 ES Frente de la tienda
 PT Frente da Tenda

JAMES BAROUD WARRANTY



5 YEARS WARRANTY - It includes the fiberglass, the mechanism, the canvas, the lift supports, the ladder and its fixings, the zippers, the mosquito net, the mattress, the rail and fixings and the headliner of the upper shell.

2 YEARS WARRANTY - It includes the gel-coat, the color, the solar fan, the flashlight and the tent locks.

In case of request of warranty support, the invoice will be requested, and photos or a film about the problem should be sent to: warranty@jamesbaroud.com. In warranty claims the tent should be packed in the original box to be transported. In the case of litigation or contestation the court of Porto, Portugal have jurisdiction.

jamesbaroud.com



@jamesbaroudofficial

✉ contact@jamesbaroud.com



OPEN

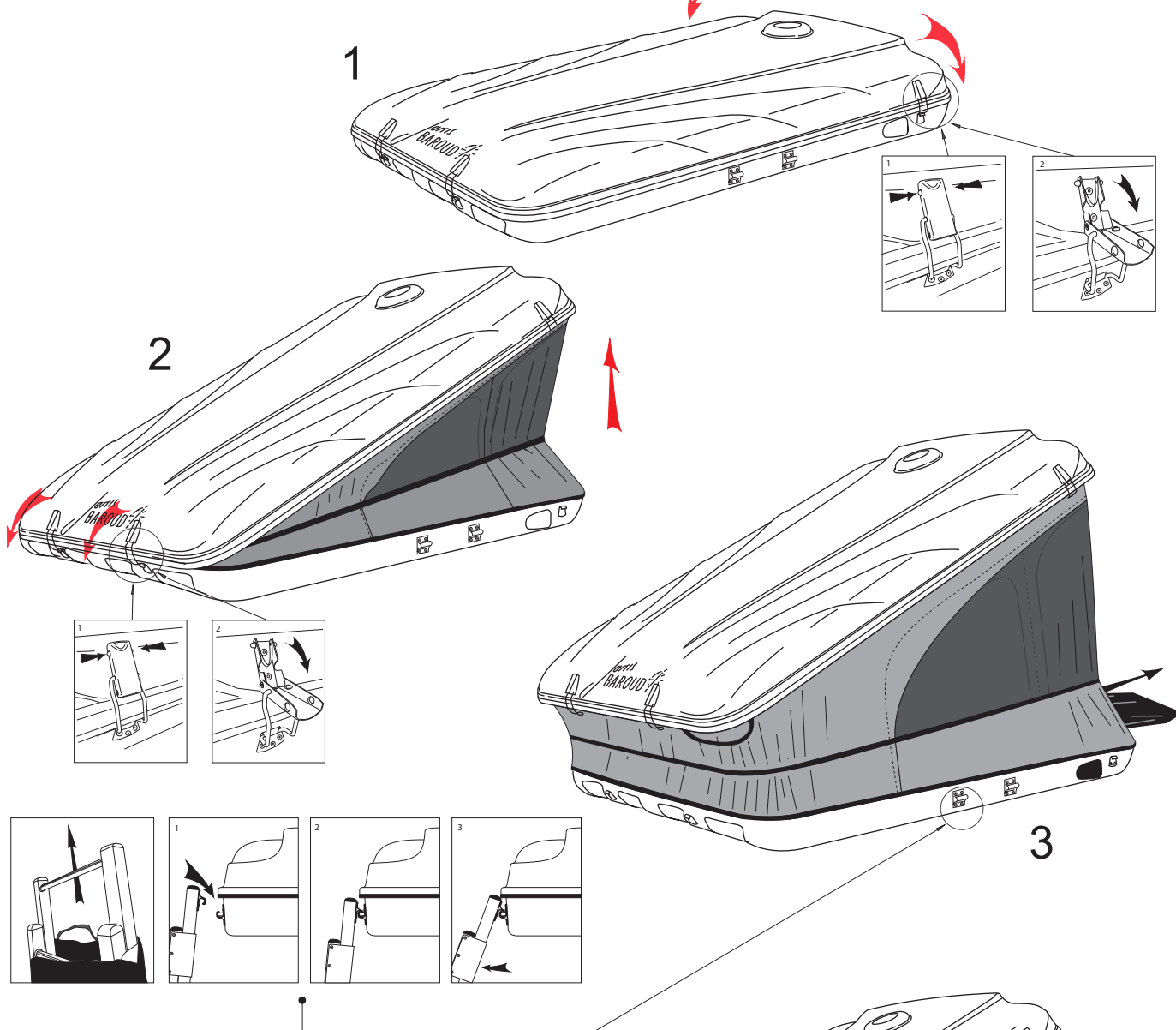

IMPORTANT!

Do not press the front or rear of the tent to close the tent at the risk of losing the warranty. Hairlines cracks in the gel coat may occur due to misuse of the product.

IMPORTANT!

Ne pas pousser dessus la tente pour fermer au risque de perdre la garantie. Une mauvaise utilisation du produit peut provoquer des microfissures dans le gel-coat.

WICHTIG!

Drücken Sie nicht auf die Vorder- oder Rückseite des Zeltes, um das Zelt zu schließen, um die Garantie zu verlieren. Risse im Gelcoat können durch Missbrauch des Produkts auftreten.

¡IMPORTANTE!

No presione la parte frontal o trasera de la tienda al cerrar sob el riesgo de perder la garantía. La mala utilización del producto pueden provocar microfissuras en el gel coat.

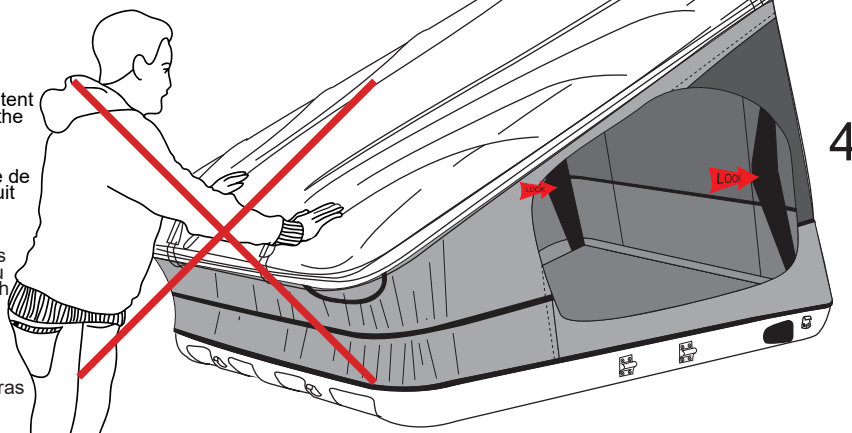

OPENING INSTRUCTIONS / INSTRUCTIONS D'OUVERTURE/ ERÖFFNUNGSVERFAHREN/ INSTRUCCIONES DE APERTURA

- | | | | |
|--|--|---|--|
| <p>1 EN/ Open rear latches
 FR/ Ouvrir les fermetures arrière
 DE/ Öffene hintere Riegel
 ES/ Abrir los cierres traseros</p> | <p>2 EN/ Open the tent rear/ Open front latches
 FR/ Ouvrir l'arrière de la tente/ Ouvrir les fermetures avant
 DE/ Öffnen Sie das Zelt Hinter/ Öffnen Sie vordere Riegel
 ES/ Abrir la parte trasera de tienda / abrir los cierres delanteros</p> | <p>3 EN/ Remove and place the ladder
 FR/ Retirer et placez l'échelle
 DE/ Setzen Die Leiter
 ES/ Retirar la escalera y colocar</p> | <p>4 EN/ Lock the tent arms
 FR/ Bloquer les bras de la tente
 DE/ Sperren Sie die Arme
 ES/ Bloquear los brazos</p> |
|--|--|---|--|

**IMPORTANT!**

Before closing the tent please turn off the solar fan.
Not turning off may cause overheating.

IMPORTANT!

Avant de fermer la tente, veuillez arrêter le ventilateur solaire.
Ne pas l'arrêter peut provoquer une surchauffe.

WICHTIG!

Bevor Sie das Zelt schließen, schalten Sie bitte den Solarlüfter aus. Nicht abschalten kann Überhitzung verursachen.

¡IMPORTANTE!

Antes de cerrar la tienda, apague el ventilador solar. No apagarlo puede causar sobrecalentamiento.

CLOSE

1

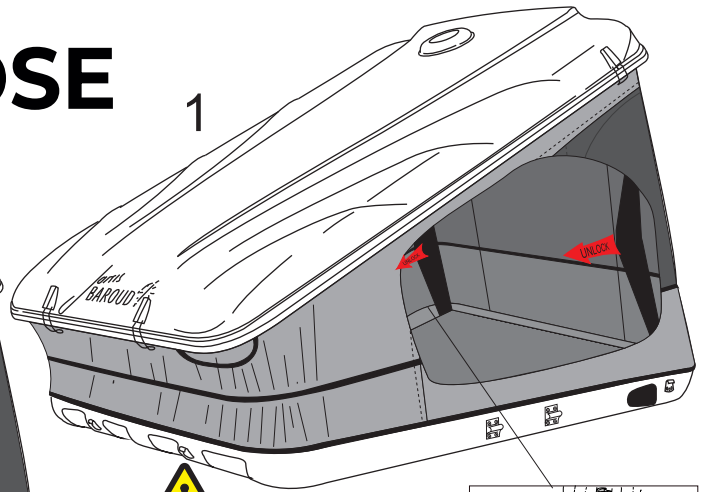

2

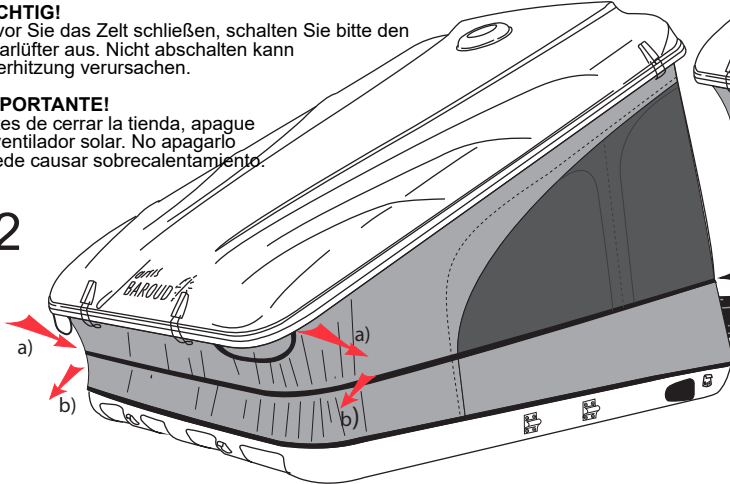
**CAUTION!**

When closing the tent place all cursors along the red marks.

ATTENTION!

Lors de la fermeture de la tente, amener les curseurs au niveau des marques rouges.

WAARSCHUWING!

Während des Schließens des Zeltes, stellen Sie cursor auf die roten Markierungen.

¡ATENCIÓN!

Al cerrar la tienda poner todos los cursores al lo largo de las marcas rojas.

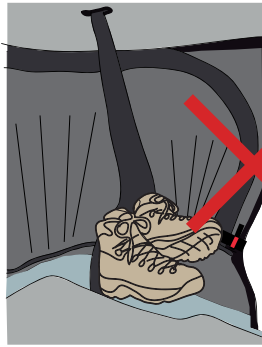
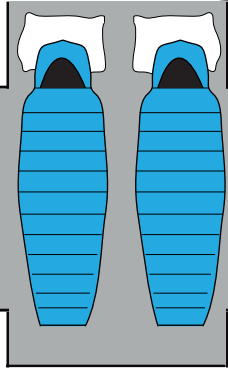
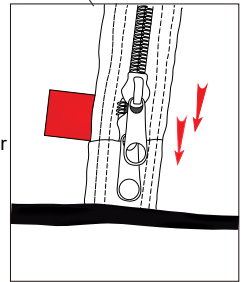
**IMPORTANT!**

When closing the tent fold the bedclothes in the corners and do not place any object under the arms of the mechanisms.

IMPORTANT!

Avant de fermer la tente plier le linge de lit dans les coins et ne placez aucun objet sous les bras des mécanismes.

WICHTIG!

Beim Schließen des Zeltes klappen Sie die Bettwäsche zusammen in den Ecken und legen Sie keine Gegenstände unter die Arme der Mechanismen.

¡IMPORTANTE!

Antes de cerrar la tienda doblar la ropa de cama en las esquinas y no coloque objetos bajo los brazos de los mecanismos.

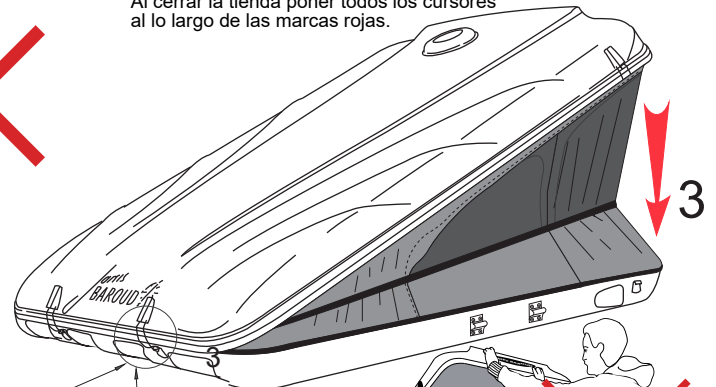

3

**IMPORTANT!**

Do not press the front or rear of the tent to close the tent at the risk of losing the warranty. Hairlines cracks in the gel coat may occur due to misuse of the product.

IMPORTANT!

Ne pas pousser dessus la tente pour fermer au risque de perdre la garantie. Une mauvaise utilisation du produit peut provoquer des micro-fissures dans le gel-coat.

WICHTIG!

Drücken Sie nicht auf die Vorder- oder Rückseite des Zeltes, um das Zelt zu schließen, um die Garantie zu verlieren. Risse im Gelcoat können durch Missbrauch des Produkts auftreten.

¡IMPORTANTE!

No presione la parte frontal o trasera de la tienda al cerrar sob el riesgo de perder la garantía. La mala utilización del producto pueden provocar micro-fisuras en el gel coat.



4

**CAUTION!**

When closing the tent do not leave fabric out.

ATTENTION!

Lors de la fermeture de la tente, ne laissez pas la toile à l'extérieur.

WAARSCHUWING!

Wenn Sie das Zelt schließen, lassen Sie den Stoff nicht draußen.

¡ATENCIÓN!

Al cerrar la tienda, no deje la tela afuera.

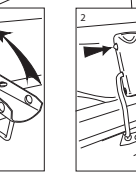
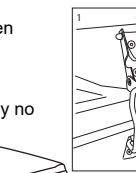
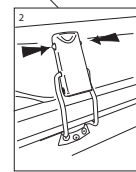
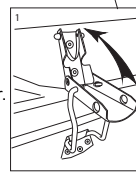
**CLOSING INSTRUCTIONS / INSTRUCTIONS DE FERMETURE / SCHLIEßENSVERFAHREN / INSTRUCCIONES DE CIERRE**

- | | | | |
|------------------------------------|--|---|-----------------------------------|
| 1 EN/ Unlock the tent arms | 2 EN/ Stow the ladder / Important: Close the tent using the front side straps (a+b) | 3 EN/ Close front latches / Close the tent rear | 4 EN/ Close rear latches |
| FR/ Débloquer les bras de la tente | FR/ Ranger l'échelle / Impératif: pour fermer la tente utiliser la poignée sur le côté (a+b) | FR/ Fermer les fermetures avant / Fermer l'arrière de la tente | FR/ Fermer les fermetures arrière |
| DE/ Lösen Sie die Arme | DE/ Vereinharen die Leiter / Schließen Sie die Zellfront mit den Vorderseitengurten | DE/ Schließen vordere Verriegelungen / Schließen Sie das Zelt | DE/ Schließen hintere Riegel |
| ES/ Desbloquear los brazos | ES/ Guardar la escalera/ Importante: Cierre la tienda utilizando las correas laterales | ES/ Cerrar los cierres delanteros/ Cerrar la parte trasera de la tienda | ES/ Cerrar los cierres traseros |